

Hoses for the Food & Pharma Industry



Hoses & Connection Systems for applications in the Food & Pharma Industry

Masterflex – Your Partner in High-tech Hose Systems

Production facilities for the pharma and food industries are subject to stringent regulations and high standards in terms of materials used. Hoses must fulfil the most stringent of hygiene requirements in order to guarantee the safe processing of products to be manufactured. Masterflex products leave nothing to be desired where the highest requirements for quality, hygiene, abrasion resistance, flexibility and load-bearing capacity are placed upon Flow-through connections. Masterflex hoses and connectors comply with the latest food and pharma industry standards and are tried, tested and certified.

This brochure provides an overview of our products, which are especially designed for industrial challenges such as suction, transportation and supply of various substances - e.g., bulk goods, powder, dusts, granulates, pigments, capsules, tablets, etc. in the food and pharma industries. It also provides some sample applications to give you an insight into the many potential uses of our hoses.

Contents

Certified hose quality from Masterflex	3
Master-PUR LF Food	4
Master-PUR LF Food A	5
Master-PUR L Food	6
Master-PUR L Food A	7
Master-PUR H Food	9
Sample applications: Production of bakery products	10
Master-PUR H Food A	11
Master-PUR HX Food	13
Master-PUR HX Food A	14
Polderflex PUR Food	16
Sample applications: Production of confectionary products	17
Polderflex PUR Food A	18
Master-PUR Flat Food A	19
Master-SIL SD Food	20
Master-Grip Double Wire Clamp, screw-fitting	21
Quick-Fix Clamp for Clone Flanges	22
Combiflex PU Cone Flange Food	23
Sample applications: Milk powder & whey powder production	24
Combiflex PU Fixed Flange Food	25
Combiflex PU Swivel Flange Food	26
Combiflex PU Threaded Sockets Food	27
Combiflex Clamp Connection Food	28
Combiflex Clamp Ring Seal	29
Sample applications: Pharmaceuticals manufacturing	30
Combiflex Clamp Connection Hinged Clamp	31
Combiflex VA Threaded Sockets Food	32
Combiflex Dairy Fitting Threaded Hose Sockets	33
Combiflex Dairy Fitting Cone Sockets	34
Combiflex Dairy Fitting Ring Seal	35

Certified hose quality from Masterflex

Not all hoses are suitable for transporting foodstuffs. Only hoses that comply with strict regulations and directives are permitted for transportation of coffee, sugar or even milk powder from A to B.

All Masterflex food-grade hoses are certified in accordance with EU regulation 10/2011 in relation to food-grade quality

Masterflex has provided certified, food-grade hoses for many years, along with compatible, high-quality connection and fastening elements. Thus, all food hoses are manufactured in accordance with EU regulation no. 10/2011 in relation to food grade quality.

This certification applies to the complete hose line, as well as all food connecting elements. All permanently antistatic Masterflex food hoses are also certified. The walls of Food A hoses have a surface resistance of $R_o < 10^9$ Ohm; hence, their discharge capacity conforms to Technical Rules for Hazardous Substances (TRGS 727) (ATEX 2014/34EU).

Since 2011, in addition to EC framework regulation 1935/2004, as well as EC regulation 2023/2006 on “good manufacturing practice”, the activities of the food processing industry have been regulated by EU regulation no. 10/2011 on the “placing on the market of plastic materials and articles”, also known as the “Plastics Implementation Measure (PIM)” in particular.

In addition to the three standards mentioned, Masterflex food hoses also comply with FDA (US Food and Drug Administration) guidelines, as well as the German Food and Feed Code (LFGB).

All of the materials used for Masterflex food hoses and connecting elements exactly fulfil these demanding national and international food product regulations and are ideally suited for use in the food and pharma industries. This has also been certified by an independent institute.

Masterflex employs a stainless steel wire spiral for all of its food hoses. Thus, the food grade quality of the

conveyed medium is maintained, even in the event of abrasion of the wall material underneath the wire spiral.

Thanks to their optimised moulding, our food hoses leave almost no material residue. They are much easier to clean and can also be assembled bi-directionally.



Master-PUR LF Food

PU Suction & Transport Hose, super lightweight, extremely flexible, food-grade quality acc. to EU 10/2011 and FDA

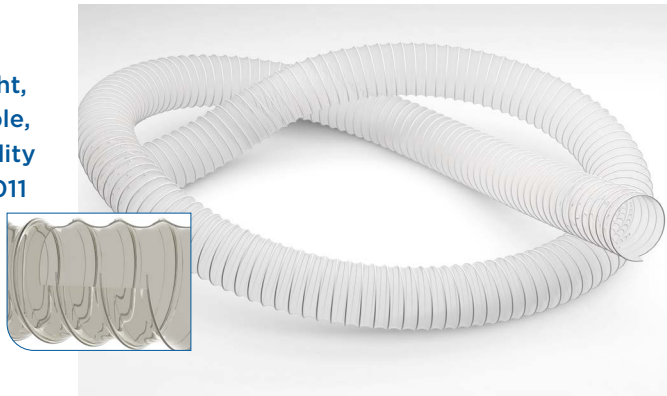

Connections:

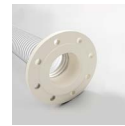

Combiflex PU-Fixed Flange Food

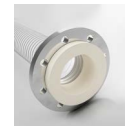

Combiflex PU Swivel Flange Food



Master-Grip Double Wire Clamp

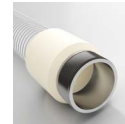

Combiflex VA Threaded Sockets Food



Combiflex PU Threaded Sockets Food



Combiflex Dairy Fitting Cone Sockets

Material

- spiral: spring steel wire (stainless steel 1.4310)
- wall: pure polyether polyurethane, food-grade quality (FDA)
- wall thickness between spirals approx. 0.5 mm

Applications

- Pharmaceutical industry
- Chemicals industry
- Food industry

Temperature Range

- -40°C to +90°C
- peaks to +125°C

Properties

- materials comply with the following food regulations: FDA 21 CFR §177.2600 and - FDA 21 CFR §178.2010
- Approved for food-grade categories: A, B, C, D1, D2, E (contact durations acc. to Test Report)
- The hose conforms with EU Guideline 10/2011

- smallest bending radii
- optimum flow characteristics
- highly flexible
- abrasion-resistant
- odourless/tasteless
- microbe and hydrolysis-resistant
- halogen and plasticizer-free
- good chemical resistance
- high tensile strength
- generally good UV and ozone resistance
- acc. to TRGS 727 and ATEX 2014/34 EU, with earthing at both ends of the spiral for non-flammable dust/bulk solids in Zone 22. For gases/liquids with low conductivity of electrostatic charges in Zone 2
- very light

DN	op. pressure bar	vacuum bar	bend radius mm*	outer Ø mm	weight/m kg	article no.**	max. production length m
40	0,82	0,24	20	46	0,28	000383:40:x	25
50	0,78	0,2	24	56	0,33	000383:50:x	25
51	0,78	0,2	25	57	0,34	000383:51:x	25
60	0,76	0,19	35	68	0,35	000383:60:x	25
70	0,61	0,16	40	78	0,41	000383:75:x	25
75	0,61	0,13	42	82	0,51	000383:75:x	25
76	0,61	0,13	43	83	0,53	000383:76:x	25
80	0,53	0,13	45	88	0,53	000383:80:x	25
90	0,46	0,09	50	99	0,6	000383:90:x	25
100	0,46	0,09	54	107	0,68	000383:100:x	25
102	0,46	0,09	55	108	0,69	000383:102:x	25
110	0,38	0,09	60	119	0,73	000383:110:x	25
120	0,38	0,09	65	129	0,82	000383:120:x	25
125	0,38	0,09	68	132	0,84	000383:125:x	25
127	0,38	0,09	70	134	0,85	000383:127:x	25
150	0,3	0,06	79	157	1	000383:150:x	25
152	0,3	0,06	80	159	1,02	000383:152:x	25
160	0,3	0,06	85	169	1,23	000383:160:x	25
180	0,23	0,06	95	189	1,38	000383:180:x	25
200	0,23	0,06	104	207	1,5	000383:200:x	25
203	0,23	0,06	105	210	1,52	000383:203:x	25
250	0,15	0,03	128	256	1,64	000383:250:x	25
254	0,15	0,03	130	260	1,64	000383:254:x	25
300	0,14	0,03	155	310	1,78	000383:300:x	25
315	0,14	0,03	162	325	1,87	000383:315:x	25
350	0,12	0,03	180	360	2,44	000383:350:x	25
400	0,12	0,03	210	410	3,04	000383:400:x	25

All data refers to a medium and ambient temperature of +20 °C. * Refers to the inner hose lining. Subject to technical changes and colour deviations. **Please replace "x" with your desired hose length

Master-PUR LF Food A

PU Suction & Transport Hose, super lightweight, food-grade quality acc. to EU 10/2011 and FDA, permanently antistatic

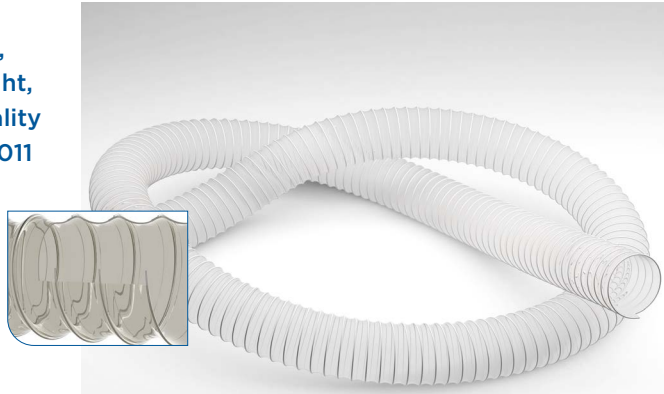

Connections:

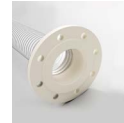

Combiflex PU-Fixed Flange Food

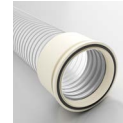

Combiflex PU Swivel Flange Food



Master-Grip Double Wire Clamp

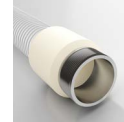

Combiflex VA Threaded Sockets Food



Combiflex PU Threaded Sockets Food



Combiflex Dairy Fitting Cone Sockets

Material

- spiral: spring steel wire (stainless steel 1.4310)
- wall: pure polyether polyurethane, food-grade (FDA), with non-migratory permanent antistatic agent
- wall thickness between spirals approx. 0.5 mm

Applications

- Pharmaceutical industry
- Chemicals industry
- Food industry

Temperature Range

- -40°C to +90°C
- peaks to +125°C

Properties

- approved acc. to TRGS 727 and ATEX 2014/34 EU
- permanently antistatic, surface resistance < 10⁹ Ohm
- The hose conforms with EU Guideline 10/2011

- smallest bending radii
- optimum flow characteristics
- highly flexible
- abrasion-resistant
- odourless/tasteless
- microbe and hydrolysis-resistant
- halogen and plasticizer-free
- good chemical resistance
- high tensile strength
- generally good UV and ozone resistance
- The material of the wall complies with the FDA food regulations 21 CFR § 177.1680 and 21 CFR § 177.2600
- very light
- Approved for food-grade category: E (contact duration acc. to Test Report)

DN	op. pressure bar	vacuum bar	bend radius mm*	outer Ø mm	weight/m kg	article no.**	max. production length m
40	0,82	0,24	20	46	0,28	000384:40:x	25
50	0,78	0,2	24	56	0,33	000384:50:x	25
51	0,78	0,2	25	57	0,34	000384:51:x	25
60	0,76	0,19	35	68	0,35	000384:60:x	25
70	0,61	0,16	40	78	0,41	000384:70:x	25
75	0,61	0,13	42	82	0,51	000384:75:x	25
76	0,61	0,13	43	83	0,53	000384:76:x	25
80	0,53	0,13	45	88	0,53	000384:80:x	25
90	0,46	0,09	50	99	0,6	000384:90:x	25
100	0,46	0,09	54	106	0,68	000384:100:x	25
102	0,46	0,09	55	108	0,69	000384:102:x	25
110	0,38	0,09	60	119	0,73	000384:110:x	25
120	0,38	0,09	65	129	0,82	000384:120:x	25
125	0,38	0,09	70	132	0,84	000384:125:x	25
127	0,38	0,09	70	134	0,85	000384:127:x	25
150	0,31	0,06	78	157	1,01	000384:150:x	25
160	0,3	0,06	85	169	1,23	000384:160:x	25
152	0,3	0,06	80	159	1,02	000384:152:x	25
180	0,23	0,06	95	189	1,38	000384:180:x	25
200	0,23	0,06	102	207	1,5	000384:200:x	25
203	0,23	0,06	105	210	1,52	000384:203:x	25
250	0,16	0,03	126	256	1,66	000384:250:x	25
254	0,15	0,03	130	260	1,65	000384:254:x	25
300	0,14	0,03	155	310	1,78	000384:300:x	25
315	0,14	0,03	162	325	1,87	000384:315:x	25
350	0,12	0,03	180	360	2,44	000384:350:x	25
400	0,12	0,03	210	410	3,04	000384:400:x	25

All data refers to a medium and ambient temperature of +20 °C. * Refers to the inner hose lining. Subject to technical changes and colour deviations. **Please replace "x" with your desired hose length

Master-PUR L Food

PU Suction & Transport Hose, light duty, highly flexible, food-grade quality acc. to EU 10/2011 and FDA

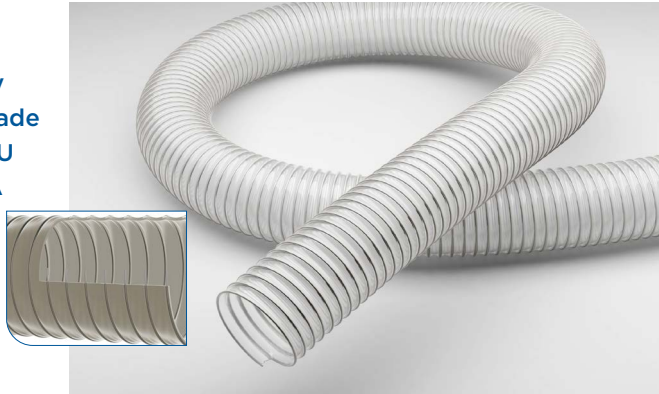

Connections:



Material

- spiral: spring steel wire (stainless steel 1.4310)
- wall: pure polyether polyurethane, food-grade quality (FDA)
- wall thickness between spirals approx. 0.7 mm

Applications

- Pharmaceutical industry
- Chemicals industry
- Food industry

Temperature Range

- -40°C to +90°C
- peaks to +125°C

Properties

- materials comply with the following food regulations:
 - FDA 21 CFR §177.2600 and - FDA 21 CFR §178.2010
- The hose conforms with EU Guideline 10/2011
- smallest bending radii

- optimum flow characteristics
- mostly smooth inner lining
- abrasion-resistant
- odourless/tasteless
- microbe and hydrolysis-resistant
- light
- very good flexibility
- halogen and plasticizer-free
- good chemical resistance
- high tensile strength
- generally good UV and ozone resistance
- Approved for food-grade categories: A, B, C, D1, D2, E (contact durations acc. to Test Report)
- acc. to TRGS 727 and ATEX 2014/34 EU, with earthing at both ends of the spiral for non-flammable dust/bulk solids in Zone 22. For gases/liquids with low conductivity of electrostatic charges in Zone 2

DN	op. pressure bar	vacuum bar	bend radius mm*	outer Ø mm	weight/m kg	article no.**	max. production length m
32	2,52	0,71	40	40	0,35	000012:32:x	25
38	2,1	0,66	46	46	0,39	000012:38:x	25
40	2,1	0,66	48	48	0,4	000012:40:x	25
45	1,84	0,59	53	53	0,44	000012:45:x	25
50	1,71	0,51	57	57	0,45	000012:50:x	25
51	1,68	0,52	58	58	0,45	000012:51:x	25
55	1,54	0,44	63	63	0,54	000012:55:x	25
60	1,4	0,44	68	68	0,53	000012:60:x	25
65	1,26	0,37	75	73	0,64	000012:65:x	25
70	1,12	0,37	80	78	0,68	000012:70:x	25
75	1,12	0,3	84	83	0,71	000012:75:x	25
76	1,12	0,29	85	84	0,72	000012:76:x	25
80	0,98	0,29	90	88	0,76	000012:80:x	25
90	0,84	0,22	99	99	0,88	000012:90:x	25
100	0,84	0,22	108	108	0,94	000012:100:x	25
102	0,84	0,22	110	110	0,95	000012:102:x	25
110	0,7	0,22	119	119	1,23	000012:110:x	25
115	0,7	0,22	124	124	1,28	000012:115:x	25
120	0,7	0,22	130	129	1,12	000012:120:x	25
125	0,7	0,22	133	133	1,17	000012:125:x	25
127	0,7	0,22	135	135	1,18	000012:127:x	25
130	0,56	0,22	141	140	1,2	000012:130:x	25
140	0,56	0,15	153	150	1,38	000012:140:x	25
150	0,56	0,15	163	159	1,47	000012:150:x	25
152	0,56	0,15	165	161	1,48	000012:152:x	25
160	0,56	0,15	170	170	1,74	000012:160:x	25
175	0,42	0,15	185	185	1,85	000012:170:x	25
180	0,42	0,15	190	190	1,9	000012:180:x	25
200	0,42	0,15	212	211	2,25	000012:200:x	25
203	0,42	0,15	215	214	2,3	000012:203:x	25

All data refers to a medium and ambient temperature of +20 °C. * Refers to the inner hose lining. Subject to technical changes and colour deviations. **Please replace "x" with your desired hose length

Master-PUR L Food A

PU Suction & Transport Hose, light duty, highly flexible, food-grade quality acc. to EU 10/2011 and FDA, permanently antistatic



Connections:

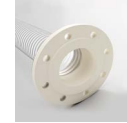

Combiflex PU-Fixed Flange Food

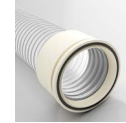

Combiflex PU Swivel Flange Food



Master-Grip Double Wire Clamp

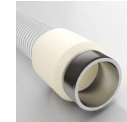

Combiflex VA Threaded Sockets Food



Combiflex PU Threaded Sockets Food

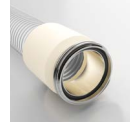

Combiflex Dairy Fitting Cone Sockets

Material

- spiral: spring steel wire (stainless steel 1.4310)
- wall: pure polyether polyurethane, food-grade (FDA), with non-migratory permanent antistatic agent
- wall thickness between spirals approx. 0.7 mm

Applications

- Pharmaceutical industry
- Chemicals industry
- Food industry

Temperature Range

- -40°C to +90°C
- peaks to +125°C

Properties

- EU guidelines EU 10/2011 and most recent amending directives
- Approved for food-grade category: E (contact duration acc. to Test Report)
- The material of the wall complies with the FDA Food

regulations 21 CFR § 177.1680 and 21 CFR § 177.2600

- permanently antistatic, surface resistance <math>< 10^9</math> Ohm, measured acc. to DIN EN ISO 8031
- approved acc. to TRGS 727 and ATEX 2014/34 EU. Details acc. to certificate
- light-duty
- very good flexibility
- smallest bending radii
- abrasion-resistant
- optimum flow characteristics
- mostly smooth inner lining
- odourless/tasteless
- microbe and hydrolysis-resistant
- halogen and plasticizer-free
- good chemical resistance
- high tensile strength
- generally good UV and ozone resistance

DN	op. pressure bar	vacuum bar	bend radius mm*	outer Ø mm	weight/m kg	article no.**	max. production length m
32	2,52	0,71	40	40	0,35	000014:34:x	25
38	2,1	0,66	46	46	0,39	000014:38:x	25
40	2,1	0,66	48	48	0,4	000014:40:x	25
45	1,84	0,59	53	53	0,44	000014:45:x	25
50	1,71	0,53	57	57	0,45	000014:50:x	25
51	1,68	0,52	58	58	0,45	000014:51:x	25
55	1,54	0,44	63	63	0,54	000014:55:x	25
60	1,4	0,44	68	68	0,53	000014:60:x	25
65	1,26	0,37	75	73	0,64	000014:65:x	25
70	1,12	0,37	80	78	0,68	000014:70:x	25
75	1,12	0,3	84	83	0,71	000014:75:x	25
76	1,12	0,29	85	84	0,72	000014:76:x	25
80	0,98	0,29	90	88	0,76	000014:80:x	25
90	0,84	0,22	99	99	0,88	000014:90:x	25
100	0,84	0,22	108	108	0,94	000014:100:x	25
102	0,84	0,22	110	110	0,95	000014:102:x	25
110	0,7	0,22	119	119	1,23	000014:110:x	25
115	0,7	0,22	124	124	1,28	000014:115:x	25
120	0,7	0,22	130	129	1,12	000014:120:x	25
125	0,7	0,22	133	133	1,16	000014:125:x	25
127	0,7	0,22	135	135	1,18	000014:127:x	25
130	0,56	0,22	141	140	1,23	000014:130:x	25
140	0,56	0,15	153	150	1,4	000014:140:x	25
150	0,56	0,15	163	159	1,57	000014:150:x	25
152	0,56	0,15	165	161	1,6	000014:152:x	25
160	0,56	0,15	170	170	1,74	000014:160:x	25
175	0,42	0,15	185	185	1,85	000014:175:x	25
180	0,42	0,15	190	190	1,9	000014:180:x	25
200	0,42	0,15	212	212	2,25	000014:200:x	25
203	0,42	0,15	215	214	2,3	000014:203:x	25

All data refers to a medium and ambient temperature of +20 °C. * Refers to the inner hose lining. Subject to technical changes and colour deviations.
**Please replace "x" with your desired hose length

Master-PUR H Food

PU Suction & Transport Hose, medium duty, very flexible, food-grade quality acc. to EU 10/2011 and FDA

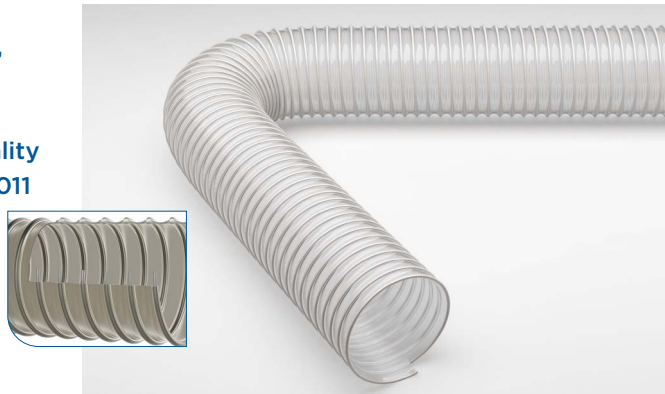

Connections:

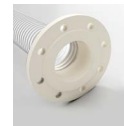

Combiflex PU-Fixed Flange Food

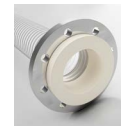

Combiflex PU Swivel Flange Food



Master-Grip Double Wire Clamp

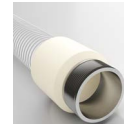

Combiflex VA Threaded Sockets Food



Combiflex PU Threaded Sockets Food

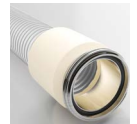

Combiflex Dairy Fitting Cone Sockets

Material

- spiral: spring steel wire (stainless steel 1.4310)
- wall: pure polyether polyurethane, food-grade quality (FDA)
- wall thickness between spirals approx. 1.4 mm

Applications

- Pharmaceutical industry
- Chemicals industry
- Food industry

Temperature Range

- -40°C to +90°C
- peaks to +125°C

Properties

- materials comply with the following food regulations:
 - FDA 21 CFR §177.2600 and - FDA 21 CFR §178.2010
- The hose conforms with EU Guideline 10/2011
- small bending radii
- optimum flow characteristics

- mostly smooth inner lining
- abrasion-resistant
- odourless/tasteless
- microbe and hydrolysis-resistant
- medium duty
- good flexibility
- halogen and plasticizer-free
- good chemical resistance
- increased pressure and vacuum resistance
- high tensile strength
- Approved for food-grade categories: A, B, C, D1, D2, E (contact durations acc. to Test Report).
- generally good UV and ozone resistance
- acc. to TRGS 727 and ATEX 2014/34 EU, with earthing at both ends of the spiral for non-flammable dust/bulk solids in Zone 22. For gases/liquids with low conductivity of electrostatic charges in Zone 2

DN	op. pressure bar	vacuum bar	bend radius mm*	outer Ø mm	weight/m kg	article no.**	max. production length m
20	4,3	0,92	45	28	0,23	000067:20:x	25
25	4,16	0,92	50	33	0,3	000067:25:x	25
26	4,16	0,92	47	33	0,29	000067:26:x	25
30	3,51	0,92	56	39	0,37	000067:30:x	25
32	3,25	0,92	60	41	0,39	000067:32:x	25
38	3,12	0,82	70	47	0,46	000067:38:x	25
40	3	0,82	70	49	0,49	000067:40:x	25
45	2,95	0,81	80	55	0,55	000067:45:x	25
50	2,9	0,8	86	60	0,68	000067:50:x	25
51	2,9	0,79	87	61	0,71	000067:51:x	25
55	2,75	0,76	95	65	0,77	000067:55:x	25
60	2,55	0,74	105	70	0,84	000067:60:x	25
65	2,4	0,66	115	75	0,91	000067:65:x	25
70	2,25	0,66	120	80	0,97	000067:70:x	25
75	2	0,6	124	86	1,05	000067:75:x	25
76	2	0,59	125	87	1,06	000067:76:x	25
80	2	0,59	135	91	1,11	000067:80:x	25
100	1,5	0,45	163	110	1,44	000067:100:x	25
102	1,5	0,44	165	112	1,48	000067:102:x	25
115	1,35	0,31	186	126	1,68	000067:115:x	25
120	1,3	0,31	195	131	1,75	000067:120:x	25
125	1,3	0,31	203	136	1,86	000067:125:x	25
127	1,3	0,31	205	138	1,91	000067:127:x	25
130	1,3	0,31	209	141	1,96	000067:130:x	25
140	1,05	0,25	224	151	2,11	000067:140:x	25
150	1,05	0,25	243	161	2,26	000067:150:x	25
152	1,05	0,25	245	163	2,29	000067:152:x	25
160	0,9	0,25	255	171	2,51	000067:160:x	25
170	0,9	0,18	255	181	2,67	000067:170:x	25
175	0,9	0,18	255	186	2,74	000067:175:x	25
180	0,75	0,18	285	191	2,82	000067:180:x	25
200	0,75	0,18	320	212	3,41	000067:200:x	25
203	0,75	0,18	325	215	3,5	000067:203:x	25

All data refers to a medium and ambient temperature of +20 °C. * Refers to the inner hose lining. Subject to technical changes and colour deviations. **Please replace "x" with your desired hose length.

Sample applications: Production of bakery products



Nowadays, many baked goods are produced in large-scale bakeries. As such, stringent legal requirements must be adhered to, and hygienic standards complied with, in order to ensure impeccable product quality.

Hoses are used at many points in an industrial bakery's chain of production. During goods delivery, for example, pulverised media such as flour or baking powder are conveyed from lorries to their corresponding silos and storage tanks. Food-grade Masterflex hoses, such as the Master-PUR HX Food or the Polderflex PUR Food, for example, are used in such instances. Positive or vacuum pressure is used to transport powder to the silos by means of pneumatic delivery. Signs of wear are not uncommon at this juncture, as high levels of abrasion can occur as a result of particle impact on the hose wall. Masterflex's highly abrasion-resistant food hoses are especially designed suited for these demanding tasks; their robust outer walls, made from polyether polyurethane, offer long endurance and effective wear resistance.

Masterflex hoses are also employed at subsequent stages of the production process: over short-distance connections such as links from pipelines to distributing stations, for example, at connections between dough mixers and VA piping, at vibrating sieves, or for extraction of warm air during the baking process.

In addition to the impact wear already mentioned, which results from abrasion, other factors such as heavy mechanical strain, moisture and heat can also affect the hose material in these kinds of applications. Depending on requirements, hoses such as the Master-PUR Flat Food offer significant flexibility for use with vibrating sieves, for example. In addition, all hoses are microbe and hydrolysis-resistant, so that they cannot be damaged by moisture.

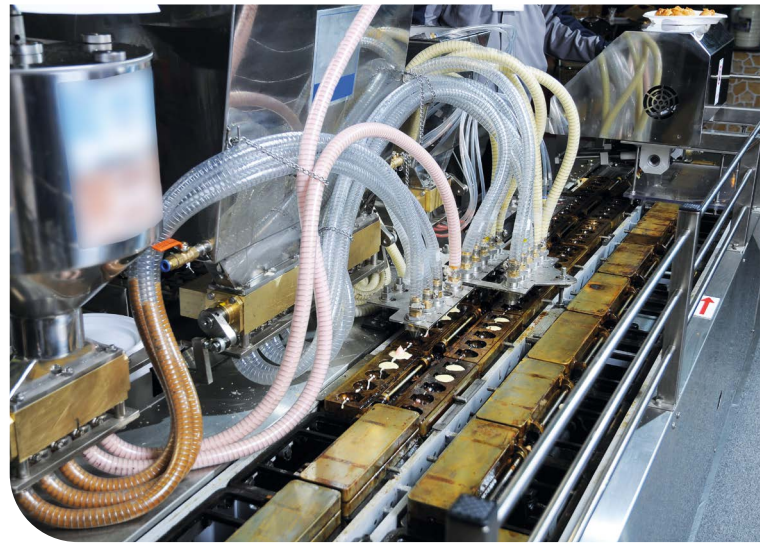

Master-PUR H Food A

PU Suciton & Transport Hose, medium duty, very flexible, food-grade quality acc. to EU 10/2011 and FDA, permanently antistatic



Connections:

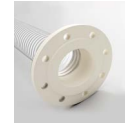

Combiflex PU-Fixed Flange Food

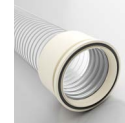

Combiflex PU Cone Flange Food



Master-Grip Double Wire Clamp

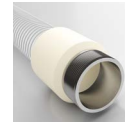

Combiflex VA Threaded Sockets Food



Combiflex PU Threaded Sockets Food

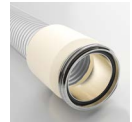

Combiflex Dairy Fitting Cone Sockets

Material

- spiral: spring steel wire (stainless steel 1.4310)
- wall: pure polyether polyurethane, food-grade (FDA), with non-migratory permanent antistatic agent
- wall thickness between spirals approx. 1.4 mm

Applications

- Pharmaceutical industry
- Chemicals industry
- Food industry

Temperature Range

- -40°C to +90°C
- peaks to +125°C

Properties

- approved acc. to TRGS 727 and ATEX 2014/34 EU. Details acc. to certificate
- permanently antistatic, surface resistance < 10⁹ Ohm
- The hose conforms with EU Guideline 10/2011

- small bending radii
- optimum flow characteristics
- mostly smooth inner lining
- abrasion-resistant
- odourless/tasteless
- microbe and hydrolysis-resistant
- medium duty
- good flexibility
- halogen and plasticizer-free
- good chemical resistance
- high tensile strength
- generally good UV and ozone resistance
- The material of the wall complies with the FDA food regulations 21 CFR § 177.1680 and 21 CFR § 177.2600
- Approved for food-grade category: E (contact duration acc. to Test Report)

DN	op. pressure bar	vacuum bar	bend radius mm*	outer Ø mm	weight/m kg	article no.**	max. production length m
20	4,3	0,92	45	28	0,23	000068:20:x	25
26	4,16	0,92	50	33	0,3	000068:26:x	25
30	3,51	0,92	56	39	0,37	000068:30:x	25
32	3,25	0,92	60	41	0,39	000068:32:x	25
38	3,12	0,82	70	47	0,46	000068:38:x	25
40	3	0,82	70	49	0,49	000068:40:x	25
45	2,95	0,81	80	55	0,55	000068:45:x	25
50	2,9	0,8	86	60	0,68	000068:50:x	25
51	2,9	0,79	87	61	0,71	000068:51:x	25
55	2,75	0,76	95	65	0,77	000068:55:x	25
60	2,55	0,74	105	70	0,84	000068:60:x	25
65	2,4	0,66	115	75	0,91	000068:65:x	25
70	2,25	0,66	120	80	0,97	000068:70:x	25
75	2	0,6	124	86	1,05	000068:75:x	25
76	2	0,59	125	87	1,06	000068:76:x	25
80	2	0,59	135	91	1,11	000068:80:x	25
90	1,65	0,52	149	101	1,25	000068:90:x	25
100	1,5	0,45	163	110	1,44	000068:100:x	25
102	1,5	0,44	165	112	1,48	000068:102:x	25
115	1,35	0,31	186	126	1,68	000068:115:x	25
120	1,3	0,31	195	131	1,75	000068:120:x	25
125	1,3	0,31	203	136	1,86	000068:125:x	25
127	1,3	0,31	205	138	1,91	000068:127:x	25
130	1,3	0,31	209	141	1,96	000068:130:x	25
140	1,05	0,25	224	151	2,11	000068:140:x	25
150	1,05	0,25	243	161	2,26	000068:150:x	25
152	1,05	0,25	245	163	2,29	000068:152:x	25
160	0,9	0,25	255	171	2,51	000068:160:x	25
170	0,9	0,18	255	181	2,67	000068:170:x	25
175	0,9	0,18	255	186	2,74	000068:175:x	25
180	0,75	0,18	285	191	2,82	000068:180:x	25
200	0,75	0,18	320	212	3,41	000068:200:x	25
203	0,75	0,18	325	215	3,5	000068:203:x	25

All data refers to a medium and ambient temperature of +20 °C. * Refers to the inner hose lining. Subject to technical changes and colour deviations.
 **Please replace "x" with your desired hose length

Master-PUR HX Food

PU Suction & Transport Hose, heavy-duty, food-grade quality acc. to EU 10/2011 and FDA



Connections:

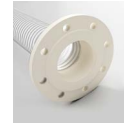

Combiflex PU-Fixed Flange Food

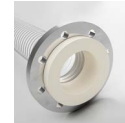

Combiflex PU Swivel Flange Food



Master-Grip Double Wire Clamp

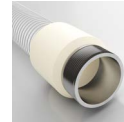

Combiflex VA Threaded Sockets Food



Combiflex PU Threaded Sockets Food



Combiflex Dairy Fitting Cone Sockets

Material

- spiral: spring steel wire (stainless steel 1.4310)
- wall: pure polyether polyurethane, food-grade quality (FDA)
- wall thickness between spirals approx. 1.7 - 2.1 mm, depending on DN

Applications

- Pharmaceutical industry
- Chemicals industry
- Food industry

Temperature Range

- -40°C to +90°C
- peaks to +125°C

Properties

- heavy-duty
- extremely abrasion resistant via specific reinforcements underneath the spiral
- materials comply with the following food regulations:
 - FDA 21 CFR §177.2600 and - FDA 21 CFR §178.2010

- The hose conforms with EU Guideline 10/2011
- optimum flow characteristics
- mostly smooth inner lining
- odourless/tasteless
- microbe and hydrolysis-resistant
- flexible
- halogen and plasticizer-free
- good chemical resistance
- increased pressure and vacuum resistance
- high tensile strength
- Approved for food-grade categories: A, B, C, D1, D2, E (contact durations acc. to Test Report)
- generally good UV and ozone resistance
- acc. to TRGS 727 and ATEX 2014/34 EU, with earthing at both ends of the spiral for non-flammable dust/bulk solids in Zone 22. For gases/liquids with low conductivity of electrostatic charges in Zone 2

DN	op. pressure bar	vacuum bar	bend radius mm*	outer Ø mm	weight/m kg	article no.**	max. production length m
32	4,85	0,94	80	42	0,66	000160:32:x	20
40	4,27	0,94	100	50	0,83	000160:40:x	20
50	4,02	0,94	123	60	1,02	000160:50:x	20
51	4	0,94	125	61	1,04	000160:51:x	20
55	3,75	0,89	140	65	1,1	000160:55:x	20
60	3,6	0,89	150	70	1,2	000160:60:x	20
65	3,3	0,89	165	75	1,29	000160:65:x	20
70	3,15	0,89	175	80	1,38	000160:70:x	20
75	2,96	0,89	188	86	1,57	000160:75:x	20
76	2,92	0,89	190	87	1,61	000160:76:x	20
80	2,77	0,89	200	93	1,93	000160:80:x	20
90	2,4	0,89	225	103	2,16	000160:90:x	20
100	2,15	0,87	246	113	2,53	000160:100:x	20
102	2,1	0,87	250	115	2,6	000160:102:x	20
110	1,95	0,87	275	124	2,82	000160:110:x	20
115	1,8	0,87	290	129	2,94	000160:115:x	20
120	1,65	0,87	300	134	3,07	000160:120:x	20
125	1,65	0,87	310	138	3,33	000160:125:x	20
127	1,65	0,87	315	140	3,44	000160:127:x	20
130	1,65	0,84	325	145	3,54	000160:130:x	20
140	1,5	0,83	350	153	3,81	000160:140:x	20
150	1,5	0,82	433	165	4,08	000160:150:x	20
152	1,5	0,82	450	167	4,13	000160:152:x	20

All data refers to a medium and ambient temperature of +20 °C. * Refers to the inner hose lining. Subject to technical changes and colour deviations.
**Please replace "x" with your desired hose length

Master-PUR HX Food A

PU suction & Transport Hose, heavy-duty, food-grade quality acc. to EU 10/2011 and FDA, permanently antistatic

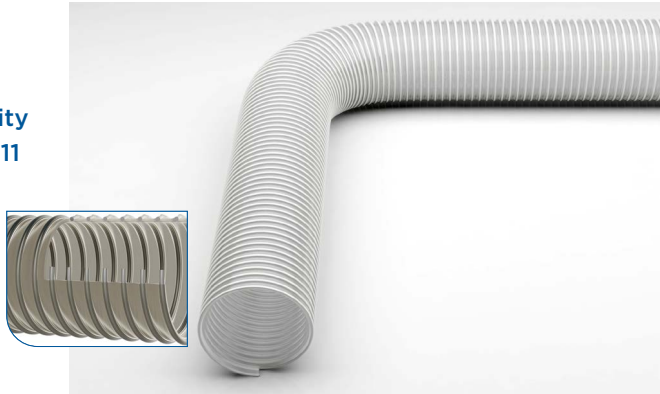

Connections:

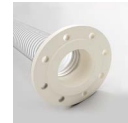

Combiflex PU-Fixed Flange Food

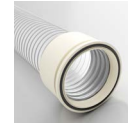

Combiflex PU Cone Flange Food



Master-Grip Double Wire Clamp



Combiflex VA Threaded Sockets Food



Combiflex PU Threaded Sockets Food

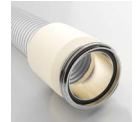

Combiflex Dairy Fitting Cone Sockets

Material

- spiral: spring steel wire (stainless steel 1.4310)
- wall: pure polyether polyurethane, food-grade (FDA), with non-migratory permanent antistatic agent
- wall thickness between spirals approx. 1.7 - 2.1 mm, depending on DN

Applications

- Pharmaceutical industry
- Chemicals industry
- Food industry

Temperature Range

- -40°C to +90°C
- peaks to +125°C

Properties

- approved acc. to TRGS 727 and ATEX 2014/34 EU
- heavy-duty
- permanently antistatic, surface resistance < 10⁹ Ohm

- extremely abrasion resistant via specific reinforcements underneath the spiral
- The hose conforms with EU Guideline 10/2011
- optimum flow characteristics
- mostly smooth inner lining
- odourless/tasteless
- microbe and hydrolysis-resistant
- flexible
- halogen and plasticizer-free
- good chemical resistance
- increased pressure and vacuum resistance
- high tensile strength
- generally good UV and ozone resistance
- The material of the wall complies with the FDA food regulations 21 CFR § 177.1680 and 21 CFR § 177.2600
- Approved for food-grade category: E (contact duration acc. to Test Report)

DN	op. pressure bar	vacuum bar	bend radius mm*	outer Ø mm	weight/m kg	article no.**	max. production length m
32	4,85	0,94	80	42	0,66	000157:32:x	20
40	4,27	0,94	100	50	0,83	000157:40:x	20
50	4,02	0,94	123	60	1,02	000157:50:x	20
51	4	0,94	125	61	1,04	000157:51:x	20
55	3,75	0,89	140	65	1,1	000157:55:x	20
60	3,6	0,89	150	70	1,2	000157:60:x	20
65	3,3	0,89	165	75	1,29	000157:65:x	20
70	3,15	0,89	175	80	1,38	000157:70:x	20
75	2,96	0,89	188	86	1,57	000157:75:x	20
76	2,92	0,89	190	87	1,61	000157:76:x	20
80	2,77	0,89	200	93	1,93	000157:80:x	20
90	2,4	0,89	225	103	2,16	000157:90:x	20
100	2,15	0,87	246	113	2,53	000157:100:x	20
102	2,1	0,87	250	115	2,6	000157:102:x	20
110	1,95	0,87	275	124	2,82	000157:110:x	20
115	1,8	0,87	290	129	2,94	000157:115:x	20
120	1,65	0,87	300	134	3,07	000157:120:x	20
125	1,65	0,87	310	138	3,33	000157:125:x	20
127	1,65	0,87	315	140	3,44	000157:127:x	20
130	1,65	0,84	325	145	3,54	000157:130:x	20
140	1,5	0,83	350	153	3,81	000157:140:x	20
150	1,5	0,82	433	165	4,08	000157:150:x	20
152	1,5	0,82	450	167	4,13	000157:152:x	20

All data refers to a medium and ambient temperature of +20 °C. * Refers to the inner hose lining. Subject to technical changes and colour deviations.
**Please replace "x" with your desired hose length

Polderflex PUR Food

PU Suction & Transport Hose, extremely pressure/vacuum-proof, smooth inner and outer linings, food-grade quality acc. to EU 10/2011 and FDA

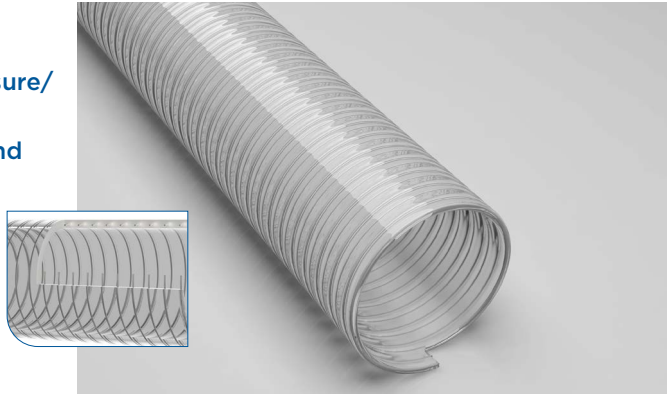

Connections:



Hose Clamp with Bolts

Material

- spiral: spring steel wire (stainless steel 1.4310)
- wall: pure polyether polyurethane, food-grade quality (FDA)
- wall thickness 3-5 mm depending on DN

Applications

- Pharmaceutical industry
- Chemicals industry
- Food industry

Temperature Range

- -40°C to +90°C
- peaks to +125°C

Properties

- extra heavyweight
- materials comply with the following food regulations:
 - FDA 21 CFR §177.2600 and - FDA 21 CFR §178.2010
- The hose conforms with EU Guideline 10/2011
- optimum flow characteristics

- highly abrasion-resistant
- odourless/tasteless
- microbe and hydrolysis-resistant
- flexible
- halogen and plasticizer-free
- smooth inner and outer linings
- good chemical resistance
- increased pressure and vacuum resistance
- high tensile strength
- generally good UV and ozone resistance
- approved for food-grade categories: A, B, C, D1, D2, E (contact durations acc. to Test Report)
- acc. to TRGS 727 and ATEX 2014/34 EU, with earthing at both ends of the spiral for non-flammable dust/bulk solids in Zone 22. For gases/liquids with low conductivity of electrostatic charges in Zone 2
- manufacturing process according to GMP EC 2023/2006

DN	op. pressure bar	vacuum bar	bend radius mm*	outer-Ø mm	weight kg/m	article no.**	max. production length m
32	5,75	0,93	160	41,5	0,88	000188:32:x	20
38	5,625	0,93	190	47,5	1,03	000188:38:x	20
40	5,5	0,93	200	49,5	1,07	000188:40:x	20
50	5,27	0,93	245	61,5	1,23	000188:50:x	20
51	5,25	0,93	250	62,5	1,25	000188:51:x	20
60	5,125	0,93	300	71,5	1,44	000188:60x	20
65	5,1	0,93	325	76,5	1,56	000188:65:x	20
70	5,05	0,93	350	81,5	1,77	000188:70:x	20
75	5,01	0,93	375	86,5	1,9	000188:75:x	20
76	5	0,93	380	87,5	1,92	000188:76:x	20
80	4,5	0,88	400	91,5	2,01	000188:80:x	20
100	4,16	0,86	580	111	3	000188:100:x	20
102	4,125	0,86	600	113	3,1	000188:102:x	20
125	3,32	0,66	692	136	3,79	000188:125:x	20
127	3,25	0,64	700	138,5	3,85	000188:127:x	20
150	2,22	0,44	792	162	4,53	000188:150:x	20
152	2,125	0,42	800	164	4,59	000188:152:x	20

All data refers to a medium and ambient temperature of +20 °C. * Refers to the inner hose lining. Subject to technical changes and colour deviations. **Please replace "x" with your desired hose length.

Production of confectionary products



A variety of methods are used to manufacture sweets, fruit gums and liquorice confectionery. However, the underlying principle is always the same: water, sugar and syrup are mixed together and brought to a suitable processing temperature. Acids, flavourings and colourants are then added until the end product results from the viscous mixture.

The various ingredients pass through a range of stages within the chain of production, up to the ready-to-eat end product. Powder and dust, as well as liquid substances such as rubber mass and syrup, for example, are conveyed and processed as part of this process. The rubber mass is heated in boilers and conveyed to mixing drums. Feed lines often consist of VA steel pipes, which are equipped with hoses via connectors to the mixing drums. Hoses offer an advantage over pipes in that they can be laid easily in confined installation conditions with small bending radii. Wear-resistant hoses and connecting elements such as the Master-PUR H Food, or the Polderflex PUR Food for example, are used in this way. The transparent outer wall provides a view of the conveyed medium at all times. Compatible connecting elements, such as fixed flanges with dairy pipe screw connections, ensure a secure connection and also facilitate rapid disconnection for cleaning or repair of hose connections.

Sugar and flavouring are conveyed to the mixing vessel further along in the process. Masterflex food hoses provide significant benefits with regard to such materials, due to their abrasion-resistant properties. Various acids also have an effect on hose material during supply of syrup or flavour enhancers. However, due to the raw material composition of Master-PUR Food hoses, long service life can be achieved even under such conditions.



Polderflex PUR Food A

PU Suction & Transport Hose, extremely pressure/vacuum-proof, smooth inner and outer linings, permanently antistatic, food-grade quality acc. to EU 10/2011 and FDA

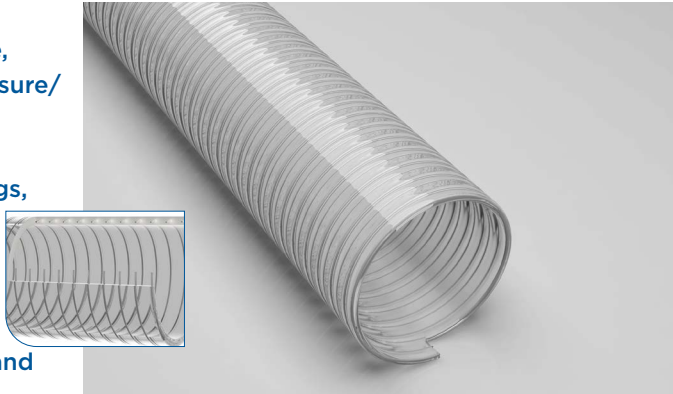

Connections:



Hose Clamp with Bolts

Material

- spiral: spring steel wire (stainless steel 1.4310)
- wall: pure polyether polyurethane, food-grade (FDA), with non-migratory permanent antistatic agent
- wall thickness 3-5 mm depending on DN

Applications

- Pharmaceutical industry
- Chemicals industry
- Food industry

Temperature Range

- -40°C to +90°C
- peaks to +125°C

Properties

- Extra Heavyweight
- approved acc. to TRGS 727 and ATEX 2014/34 EU. Details acc. to certificate
- surface resistance < 10⁹ Ohm

- The hose conforms with EU Guideline 10/2011
- optimum flow characteristics
- highly abrasion-resistant
- odourless/tasteless
- microbe and hydrolysis-resistant
- flexible
- halogen and plasticizer-free
- good chemical resistance
- increased pressure and vacuum resistance
- high tensile strength
- generally good UV and ozone resistance
- The material of the wall complies with the FDA food regulations 21 CFR § 177.1680 and 21 CFR § 177.2600
- Approved for food-grade category: E (contact duration acc. to Test Report)

DN	op. pressure bar	vacuum bar	bend radius mm*	outer Ø mm	weight/m kg	article no.**	max. production length m
32	5,75	0,93	160	41,5	0,88	000189:32:x	20
38	5,625	0,93	190	47,5	1,03	000189:38:x	20
40	5,5	0,93	200	49,5	1,07	000189:40:x	20
50	5,27	0,93	245	61	1,23	000189:50:x	20
51	5,25	0,93	250	62,5	1,25	000189:51:x	20
60	5,125	0,93	300	71,5	1,44	000189:60:x	20
65	5,1	0,93	325	76,5	1,56	000189:65:x	20
70	5,05	0,93	350	81,5	1,77	000189:70:x	20
75	5	0,93	377	87	1,91	000189:75:x	20
76	5	0,93	380	87,5	1,92	000189:76:x	20
80	4,5	0,88	400	91,5	2,01	000189:80:x	20
100	4,15	0,86	580	111	3	000189:100:x	20
102	4,125	0,86	600	113	3,1	000189:102:x	20
125	3,32	0,66	690	136	3,79	000189:125:x	20
127	3,25	0,64	700	138,5	3,85	000189:127:x	20
150	2,22	0,44	790	162	4,53	000189:150:x	20
152	2,125	0,42	800	164	4,59	000189:152:x	20

All data refers to a medium and ambient temperature of +20 °C. * Refers to the inner hose lining. Subject to technical changes and colour deviations.
**Please replace "x" with your desired hose length

Master-PUR Flat Food A

Spiral free PU transport hose, lightweight, permanent antistatic, very good flexibility, food safe EU10/2011 and FDA

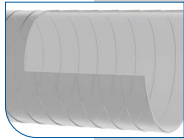

Connections:



Hose Clamp with Bolts



Hose Clamp with Worm-Gear

Material

- Wall: pure polyether polyurethane, food safe (FDA / EU10/2011), with non-migrating permanent antistatic agent
- wall thickness approx. ca. 1,0 mm

Applications

- use as compensator
- spiral-free conveying hose for abrasive solids
- solids
- solids transport at screening machines
- discharge hose at loading stations
- food industry
- pharmaceutical industry
- chemistry

Temperature Range

- -40°C to +90°C
- peaks to +125°C

Properties

- permanently antistatic, surface resistance $R_o < 10^9$ Ohm, measured according to DIN EN ISO 8031
- the hose is compliant with Regulation (EU) No. 10/2011
- approved for food category: E (contact times according to test report)
- Materials comply with the following food law regulations:
 - FDA 21 CFR §177.2600 - FDA 21 CFR §178.2010
- Manufacturing process according to GMP EC 2023/2006
- extremely vibration resistant
- smooth inside
- permanently kink-resistant
- optimum fluidic properties
- highly abrasion resistant
- high tensile and tear strength
- generally good UV and ozone resistance

DN	weight/m kg	article no.*	max. production length m
70	0,33	009111:70:x	5
75	0,36	009111:75:x	5
76	0,36	009111:76:x	5
80	0,38	009111:80:x	5
90	0,43	009111:90:x	5
102	0,48	009111:102:x	5
110	0,52	009111:110:x	5
115	0,54	009111:115:x	5
120	0,57	009111:120:x	5
127	0,60	009111:127:x	5
130	0,61	009111:130:x	5
140	0,66	009111:140:x	5
152	0,72	009111:152:x	5
160	0,75	009111:160:x	5
170	0,80	009111:170:x	5
175	0,82	009111:175:x	5
180	0,85	009111:180:x	5
203	0,95	009111:203:x	5
225	1,06	009111:225:x	5
254	1,19	009111:254:x	5
280	1,31	009111:280:x	5
305	1,43	009111:305:x	5

All data refers to a medium and ambient temperature of +20 °C. Refers to the inner hose lining. Subject to technical changes and colour deviations.
*Please replace "x" with your desired hose length

Master-SIL SD Food

Silicone Pressure Hose, Food-grade Quality (FDA)

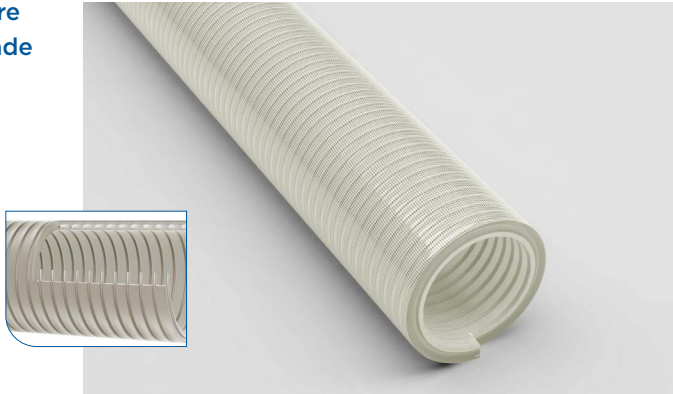

Connections:



Hose Clamp with Bolts

Material

- spiral: spring steel wire (stainless steel 1.4310)
- wall: multi-layered polyester fabric coated with platinum cured, transparent silicone, outer lining white, food-grade (FDA)
- Wall thickness approx. 5.0 mm

Applications

- When using the corresponding connectors, the hose can remain in the pipeline for cleaning purposes
- Suction and transport hose for powder and liquid media in the food industry
- Machine development for cosmetic products
- Pharmaceutical industry
- Chemicals industry
- Food industry

Temperature Range

- -60°C to +200°C

Properties

- small bending radii
- optimum flow characteristics
- odourless/tasteless
- flexible
- smooth inner and outer linings
- Food-grade conformal acc. to BfR and FDA standards and therefore fully suitable for applications in food industry
- USP Class VI certified
- steam resistant
- good chemical resistance
- high pressure resistance

DN	op. pressure bar	vacuum bar	bend radius mm*	outer Ø mm	weight/m kg	article no.**	max. production length m
13	11	0,88	40	23	0,42	000491:13:x	20
16	10	0,88	45	26	0,5	000491:16:x	20
19	10	0,88	55	29	0,57	000491:19:x	20
25	9	0,88	65	35	0,71	000491:25:x	20
32	8	0,88	95	42	0,87	000491:32:x	20
38	7	0,88	110	48	1,1	000491:38:x	20
51	6	0,88	150	60	1,37	000491:51:x	20
65	5	0,88	180	75	1,8	000491:65:x	20
76	4	0,88	240	87	2,15	000491:76:x	20
100	2,5	0,88	360	112	3,1	000491:100:x	20

All data refers to a medium and ambient temperature of +20 °C. * Refers to the inner hose lining. Subject to technical changes and colour deviations. **Please replace "x" with your desired hose length

Master-Grip Double Wire Clamp, screw-fitting

Special clamp with double-wire system, stainless steel, for right-winding hoses/ducting



Material

- stainless steel 1..4301

Applications

- Special clamp for attaching light and medium-weight, right-winding spiral hoses/ducting such as Flamex B-se, Flamex B-F se, Master-PUR Trivolution, Master-PUR Food, Master-PVC and Master-SANTO

Properties

- easy to install
- robust
- high sealing force
- extra tight connection via special double-wire system

Article No.	Clamping range in mm	Inventory item
002193	31 - 37	JA
002194	38 - 46	JA
002195	51 - 61	JA
002196	63 - 73	JA
002197	77 - 86	JA
002198	83 - 96	JA
002199	90 - 110	JA
002200	101 - 121	JA
002201	119 - 135	JA
002202	146 - 160	JA
002203	154 - 170	JA
002204	167 - 182	JA
002205	197 - 217	JA
002206	220 - 240	JA
002207	246 - 266	JA

All data refers to a medium and ambient temperature of +20 °C. Refers to the inner hose lining. Subject to technical changes and colour deviations.

Quick-Fix Clamp for Cone Flanges

in acc. with
DIN 3016



Material

- stainless steel 1.4301

Applications

- Reductions with cone flanges
- Combiflex PU cone flanges
- Steel piping with cone flanges
- Pipe bends/elbows with cone flanges
- for quick connectors from: Metal columns with cone flanges

Properties

- easy to install
- rust-free
- with safety pin to prevent from an inadvertent opening
- robust
- quick-fix clamps for cone flanges in acc.to DIN 3016

DN	D mm (min. free space)	R mm (free space for opening)	Weight/kg/piece	Article No.
50	147	103	0,2	002183
65	158	103	0,26	002184
80	169	103	0,29	002185
100	212	170	0,46	002186
125	241	186	0,78	002187
150	266	202	0,86	002188
160	275	207	0,91	002189
180	289	215	0,97	002190
200	313	228	1,05	002191
250	360	254	1,24	002192

All data refers to a medium and ambient temperature of +20 °C. Subject to technical changes and colour deviations.

Combiflex PU Cone Flange Food

in acc. with
DIN 3016,
cast-on, food
grade EU 10/2011

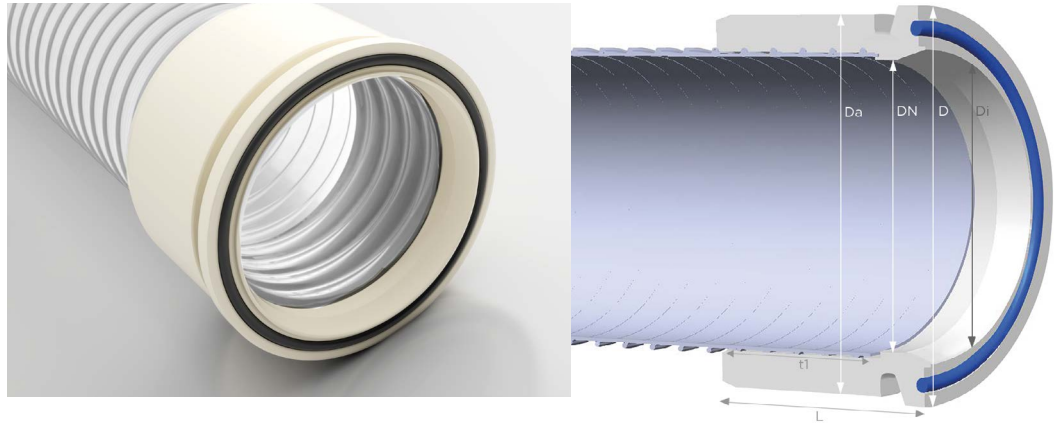

Material

- colour: white
- collar: food-grade polyurethane acc. to EU directive 10/2011 and BfR XXXIX

Applications

- Cast-on quick connectors for all Master-PUR Food hose types

Temperature Range

- -40°C to +90°C
- peaks to +125°C

Properties

- lightweight
- shock-proof

- connection option without adjustable constriction of the cross-section
- PU-sprue: approved for direct contact with foodstuffs acc. to EU directives 10/2011, 1935/2004 (German Consumer Goods Board) and their latest amendments 1282/2011, 1183/2012, 202/2014 and 2015/174 suitable for dry, watery, acidic, fatty as well as alcoholic foodstuffs (excluding spirits)
- high tension-proof
- easy to install when using quick-fit clamp connectors
- abrasion, microbe and hydrolysis resistant
- dissipation of electrostatic charge via integrated earthing plate available for prefixed version

Product Variations

DN hose	Total length mm	Weight kg/piece	Article no. male part	Article no. female part
50	68	0,1	006919	005507
65	78	0,15	005409	005410
80	83	0,18	005581	005429
100	88	0,35	005445	005532
125	95	0,42	005455	005457z
150	105	0,63	005550	005465
160	105	0,7	005472	005471
200	110	0,87	005478	005477

All data refers to a medium and ambient temperature of +20 °C. Subject to technical changes and colour deviation.

Production on request

- Order-specific production in above listed sizes, in White, pre-fixed, water-tight version for Master-PUR Food hoses

Technical data

DN hose	D: outer Ø flange	Da: outer Ø sprue	L: total length	di: tube inner diameter
50	78	75	68	54,5
65	91	90	78	70,3
80	104	105	83	82,5
100	129	131	88	107,1
125	161	156	95	131,7
150	190	184	105	159,3
160	200	190	105	167
180	216	210	110	182,9
200	242	235	110	207,3

All data refers to a medium and ambient temperature of +20 °C. Subject to technical changes and colour deviation.

Milk powder & whey powder production



Milk powder offers a range of different possible uses. It is used to manufacture numerous products, including cheese, yoghurt, confectionery and baked goods, as a basis for instant baby formula, and in the production of chocolate in particular. Whey powder is used to manufacture food products such as margarine and confectionery, amongst other things, and is also used as pig feed.

Water is withdrawn from the base product (milk or liquid whey) through the drying process during production of milk powder or whey powder.

Spray drying, agglomeration and mixing plants are commonplace in the food industry wherever milk fats and vegetable fats are processed. The production processes for skimmed milk powder, whey powder, milk powder for baby formula, fat powder or coffee creamer encompass supply of raw materials, pre-processing, the concentration process and drying, right up to packaging of finished products. Masterflex hoses are used in many drying facilities during materials transport - behind cyclones, for instance, or in the silo area or weighing cells, as well as in filling.

Processes such as drying and mixing also determine processing of further dried products such as instant drinks, custard powder, ready-made soups, tea, baking mixes, muesli, cappuccino or cereals. In these cases, too, Masterflex hoses reliably transport raw materials and finished products such as plant extracts, flavourings or seasonings, for example.



Combiflex PU Fixed Flange Food

for counterflanges
acc. to DIN 2632/
DIN 2633/ DIN 2673,
food-grade quality
acc. to EU 10/2011

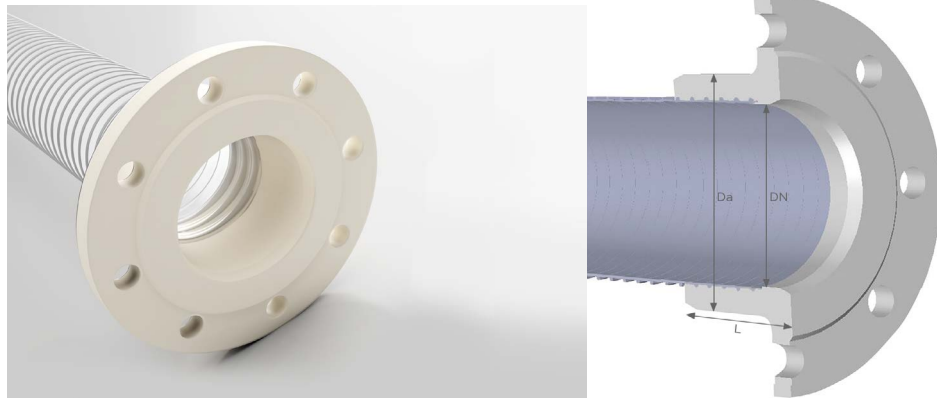

Material

- food-grade polyurethane acc.to EU 10/2011 and BfR XXXIX

Applications

- Cast-on plastic flange for all Master-PUR Food hose-types

Temperature Range

- -40°C to +90°C
- peaks to +125°C

Properties

- lightweight
- shock-proof
- connection option without adjustable constriction of the cross-section

- PU-sprue: approved for direct contact with foodstuffs acc.to EU directives 10/2011, 1935/2004 (German Consumer Goods Board) and their latest amendments 1282/2011, 1183/2012, 202/2014 and 2015/174 suitable for dry, watery, acidic, fatty as well as alcoholic food-stuffs (excluding spirits)
- high tension-proof
- simple mounting
- abrasion, microbe and hydrolysis resistant
- Pressure range PN 10/16
- dissipation of electrostatic charge via integrated earthing plate available for prefixed version

Product Variations

DN flange	dA: outer Ø Pipe	DN hose	Both circle in mm	Total length	Weight/piece	Article no.
50	57	50	125	66	0,55	005502
50	60,3	50	125	66	0,55	001903
65	76,1	65	145	76	0,69	005515
80	88,9	80	160	76	0,85	005433
100	108	100	180	86	1,13	005617
100	114,3	100	180	86	1,13	005591

All data refers to a medium and ambient temperature of +20 °C. Subject to technical changes and colour deviation.

Production on request

- Order-specific production in above listed sizes, in White, pre-fixed, water-tight version for Master-PUR Food hoses

Technical data

DN hose	Da: outer-Ø cast part	L: Total length
50	75	66
65	90	76
75	105	76
100	131	86
120	156	92
125	156	92

All data refers to a medium and ambient temperature of +20 °C. Subject to technical changes and colour deviation.

Combiflex PU Swivel Flange Food

for counterflanges
acc. to DIN 2633/
DIN 2633/ DIN 2673,
food-grade quality
acc. to EU 10/2011

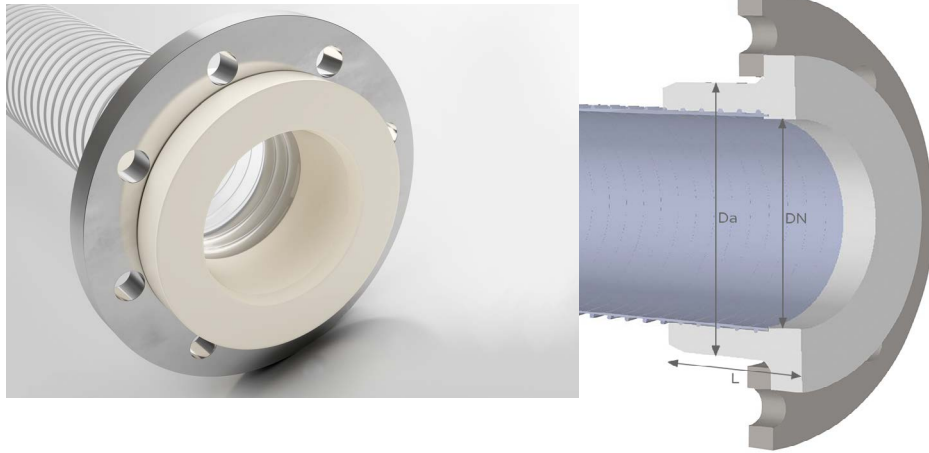

Material

- colour: white
- collar: food-grade polyurethane acc. to EU directive 10/2011 and BfR XXXIX
- loose flange: stainless steel

Applications

- Cast-on plastic flange for all Master-PUR Food hose types

Temperature Range

- -40°C to +90°C
- peaks to +125°C

Properties

- approved for direct contact with foodstuffs acc.to EU directives 10/2011, 1935/2004 (German Consumer

Goods Board) and their latest amendments 1282/2011, 1183/2012, 202/2014 and 2015/174 suitable for dry, watery, acidic, fatty as well as alcoholic foodstuffs (excluding spirits) lightweight

- shock-proof
- connection option without adjustable constriction of the cross-section
- high tension-proof
- simple mounting
- abrasion, microbe and hydrolysis resistant
- Pressure range PN 10/16

Product Variations

DN flange	dA: outer Ø Pipe	DN hose	both circle in mm	Total length	Weight/piece	Article no.
50	57	50	125	66	2,24	005503
50	60,3	50	125	66	2,24	005504
65	76,1	65	145	76	2,8	005516
80	88,9	75	160	76	3,39	001982
80	88,9	80	160	76	3,34	005430
100	108	100	180	86	3,79	005618
100	114,3	100	180	86	3,79	001986
125	133	125	210	92	4,86	001987
150	159	150	240	98	5,9	005464
150	177,8	160	240	98	5,61	001989

All data refers to a medium and ambient temperature of +20 °C. Subject to technical changes and colour deviation.

Production on request

- Order-specific production in above listed sizes, in White, pre-fixed, water-tight version for Master-PUR Food hoses

Technical data

DN hose	Da: outer-Ø cast part	L: total length
50	75	66
65	90	76
80	105	76
100	131	86
125	156	92
150	184	98

All data refers to a medium and ambient temperature of +20 °C. * Refers to the inner hose lining. Subject to technical changes and colour deviation.

Combiflex PU Threaded Sockets Food

in acc. with DIN
ISO 228 food-grade
quality acc. to
EU 10/2011

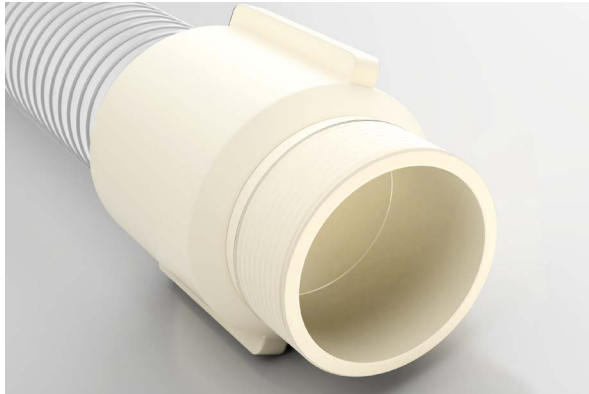

Material

- food-grade polyurethane acc.to EU 10/2011 and BfR XXXIX
- colour: white

Applications

- Cast-on threaded connectors for all Master-PUR Food hose types

Temperature Range

- -40°C to +90°C
- peaks to +125°C

Properties

- lightweight
- shock-proof
- PU-sprue: approved for direct contact with foodstuffs acc.to EU directives 10/2011, 1935/2004 (German Consumer Goods Board) and their latest amendments 1282/2011, 1183/2012, 202/2014 and 2015/174 suitable for dry, watery, acidic, fatty as well as alcoholic foodstuffs (excluding spirits)
- simple mounting
- abrasion-resistant
- microbe and hydrolysis-resistant

DN hose	G inch	Total length mm	Weight/piece	Article no.
50	2	83	0,15	005397
65	2,5	94	0,22	005408
100	4	124	0,51	005588
125	5	100	0,6	001480
150	6	109	0,9	005462

All data refers to a medium and ambient temperature of +20 °C. Subject to technical changes and colour deviations.

Combiflex Clamp Connection Food

with outer thread,
acc.to DIN ISO 228 -
cast-on food-grade
quality acc. to EU
10/2011

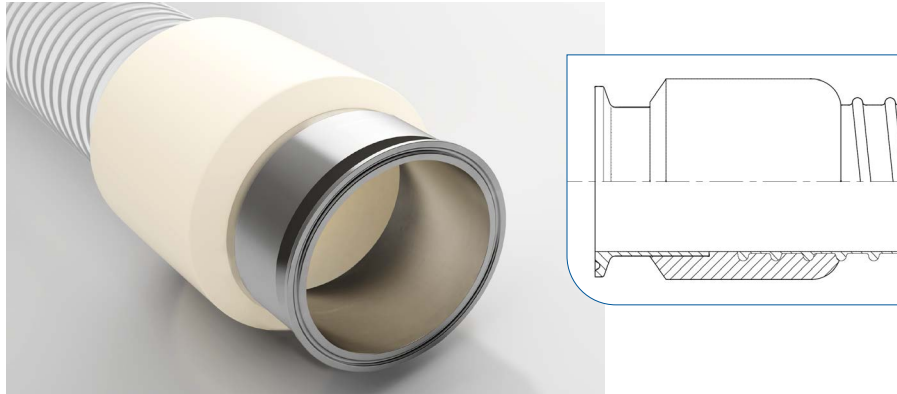

Material

- colour: white
- collar: food-grade polyurethane acc. to EU directive 10/2011 and BfR XXXIX
- VA threaded sockets

Applications

- for application for connectors to machines and piping
- for mounting of valves for solid, liquid and gaseous media
- Cast-on VA (stainless steel) screw connectors with external thread acc. to DIN ISO 228 for all Master-PUR-Food hoses
- Pharmaceutical industry
- Chemicals industry
- Food industry

Temperature Range

- -40°C to +90°C
- peaks to +125°C

Properties

- watertight
- rust-free
- PU-sprue: approved for direct contact with foodstuffs acc.to EU directives 10/2011, 1935/2004 (German Consumer Goods Board) and their latest amendments 1282/2011, 1183/2012, 202/2014 and 2015/174 suitable for dry, watery, acidic, fatty as well as alcoholic food-stuffs (excluding spirits)
- good flow characteristics
- odourless/tasteless
- good chemical resistance
- high tensile strength
- dissipation of electrostatic charges via grounding connection between hose and valve/fitting

DN hose	outer Ø gate	Da: outer-Ø cast partmm	Weight/piece incl. gate	Article no. gate	Article no. clamp-connection
32	32	52	0,41	005376	005496
38	40	60	0,5	005380	005379
40	40	60	0,48	005384	005385
50	50	71	0,64	005389	004611
65	66	91	1,06	005405	005412
75	80	106	1,5	005421	005428
80	80	106	1,43	005427	005428
100	100	130	2,05	005435	005444
125	125	156	1,48	005450	005542
150	150	184	1,78	005466	004617

All data refers to a medium and ambient temperature of +20 °C. Subject to technical changes and colour deviations.

Combiflex Clamp Ring Seal

for clamp
connections
acc.to DIN 32676



Material

- NBR, Colour. white

Applications

- for application for connectors to machines and piping
- Sealing rings for solid, liquid and gaseous media in food, pharmaceutical and chemicals industries
- Sealing rings for hose brackets with clamp connector acc. to DIN 32676 series A

Temperature Range

- -25°C to +120°C
- peaks to +150°C

Properties

- materials adhere to the food-grade regulations DIN 32676 series A
- provides watertight connections
- odourless/tasteless
- good chemical resistance
- high tensile strength

DS	inner Ø Di mm	outer Ø Da mm	Article no.
32	32,2	52,7	002462
40	38,2	52,7	002465
50	50,2	66,2	002468
65	66,2	93,2	002472
80	81,2	108,2	002476
100	100,2	121,2	002480
125	125,2	155	002483
150	150,2	183	002485

All data refers to a medium and ambient temperature of +20 °C. Subject to technical changes and colour deviations.

Sample applications in pharmaceuticals manufacturing



In the area of bulk goods handling - For example in the pharma industry - the hoses employed are subjected to high levels of strain. They provide connections between pipelines and, for example, a vacuum conveyor or, in some circumstances, can extend directly to a product feeding point or a container. They serve to provide suction from charging hoppers, big bags or containers and must withstand heavy loads and fulfil the highest standards of quality.

Particularly in the pharma industry, great importance is attached to the highest possible hygiene requirements and to the ability to be cleaned without leaving residues. Products, their packaging, and all commodities must undergo strict inspections throughout the entire chain of production.

Commodities which come into contact with products must not cause product contamination or compromise their quality. Therefore, Masterflex food hoses - along with all foodstuff-compatible products - are subject to EC regulation no. 2023/2006/EC, also known as GMP: "good manufacturing practice".



The hoses are used for suction, transportation and supply of various substances such as powders, dusts, granules, pigments, capsules, tablets or small parts. During transport of media in powder form, in particular, it is important to avoid unloading due to electrostatic charges and to minimise the risk of dust explosion. Therefore, all Masterflex food hoses are also available as antistatic versions.



Combiflex Clamp Connection Hinged Clamp

for clamp
Connections
acc.to DIN 32676



Material

- stainless steel 1..4301

Applications

- Fitting for solid, liquid and gaseous media in food, pharmaceuticals and chemicals industries
- for application for connectors to machines and piping

Properties

- materials adhere to the food-grade regulations DIN 32676 series A
- provides watertight connections
- odourless/tasteless
- can be steam-sterilized
- good chemical resistance
- high tensile strength

DS	Weight/piece kg	Article no.
32	0,23	-
40	0,23	002463
50	0,31	002466
65	0,31	002470
80	0,41	002474
100	0,41	002478
125	1,17	002481
150	1,34	-

All data refers to a medium and ambient temperature of +20 °C. Subject to technical changes and colour deviations.

Combiflex VA Threaded Sockets Food

with outer thread,
acc.to DIN ISO 228
- cast-on, food-
grade quality acc.
to EU 10/2011

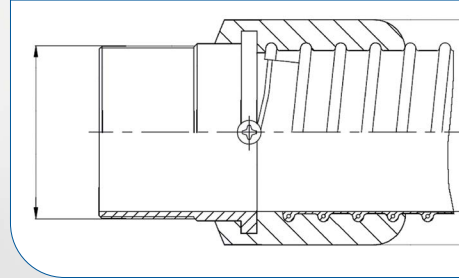
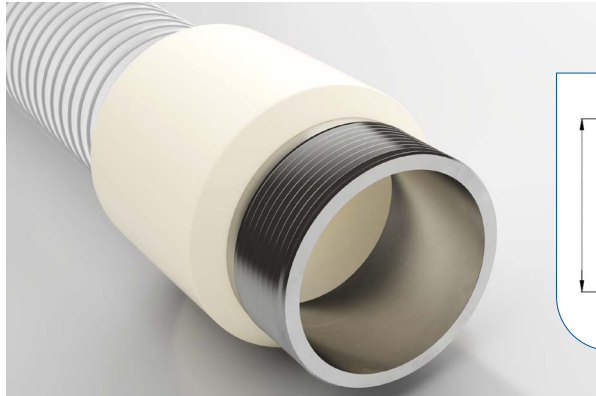

Material

- colour: white
- collar: food-grade polyurethane acc. to EU directive 10/2011 and BfR XXXIX
- VA threaded socket

Applications

- for application for connectors to machines and piping
- for mounting of valves for solid, liquid and gaseous media
- Cast-on VA (stainless steel) screw connectors with external thread acc. to DIN ISO 228 for all Master-PUR-Food hoses
- Pharmaceutical industry
- Chemicals industry
- Food industry

Temperature Range

- -40°C to +90°C
- peaks to +125°C

Properties

- watertight
- rust-free
- PU-sprue: approved for direct contact with foodstuffs acc.to EU directives 10/2011, 1935/2004 (German Consumer Goods Board) and their latest amendments 1282/2011, 1183/2012, 202/2014 and 2015/174 suitable for dry, watery, acidic, fatty as well as alcoholic food-stuffs (excluding spirits)
- good flow characteristics
- odourless/tasteless
- dissipation of electrostatic charges via grounding connection between hose and valve/fitting
- good chemical resistance
- high tensile strength

Production on request

- Order-specific production in above listed sizes, in White, pre-fixed, water-tight version for Master-PUR Food hoses

DN hose	Connector thread size (in.) inch	Da: outer diameter gate mm	Weight/piece incl. gate kg	Article no.gate	Article no. threaded socket
25	1	42	0,19	005493	005494
32	1 1/4	52	0,34	005376	-
38	1 1/2	60	0,42	005380	005382
40	1 1/2	60	0,42	005384	-
50	2	71	0,55	005389	005401
65	2 1/2	90	0,82	005405	005518
75	3	106	1,34	005421	005526
80	3 1/2	106	0,96	005427	-
100	4	130	1,94	005435	005440
125	5	155	2,43	005450	-
150	6	184	2,98	005466	005556

All data refers to a medium and ambient temperature of +20 °C. Subject to technical changes and colour deviations.

Combiflex Dairy Fitting Threaded Hose Sockets

acc.to 11851 -
cast-on/pre-fixed,
food-grade quality
acc. to EU 10/2011

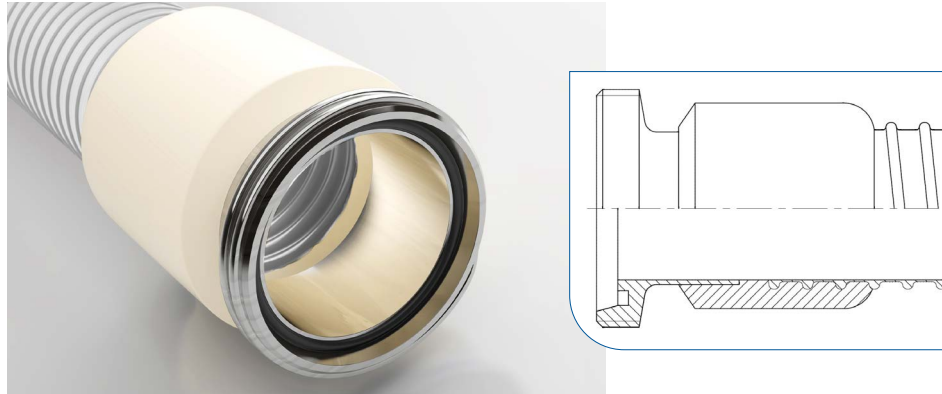

Material

- colour: white
- collar: food-grade polyurethane acc. to EU directive 10/2011 and BfR XXXIX
- threaded hose sockets acc.to DIN 11851: stainless steel
- ring seal: NBR, colour: blue

Applications

- Cast-on pipe screw connection acc. to DIN 11851 for Master-PUR Food hoses
- Fitting for solid, liquid and gaseous media in food, pharmaceuticals and chemicals industries

Temperature Range

- -40°C to +90°C
- peaks to +125°C

Properties

- watertight
- rust-free

- PU-sprue: approved for direct contact with foodstuffs acc.to EU directives 10/2011, 1935/2004 (German Consumer Goods Board) and their latest amendments 1282/2011, 1183/2012, 202/2014 and 2015/174 suitable for dry, watery, acidic, fatty as well as alcoholic food-stuffs (excluding spirits)
- good flow characteristics
- threaded supports: materials acc.to food industry regulations DIN 11851
- odourless/tasteless
- good chemical resistance
- high tensile strength
- dissipation of electrostatic charges via grounding connection between hose and valve/fitting

Production on request

- Order-specific production in listed sizes for Master PUR Food hoses.

DN hose	Access DS	Thread (DG) acc.to DIN 405-1	Weight/piece incl. gate kg	Article no. gate	Article no. threaded socket	Article no. cone socket
32	32	RD 58x1/6	0,46	005376	005378	005377
38	40	RD 65x1/6	0,5	005380	-	005381
40	40	RD 65x1/6	0,58	005384	-	005498
50	50	RD 78x1/6	0,72	005389	005391	005392
65	65	RD 95x1/6	0,97	005405	005520	005404
75	80	RD 110x1/4	1,2	005421	-	005420
80	80	RD 110x1/4	1,3	005427	005528	005426
100	100	RD 130x1/4	2,1	005435	005446	005434
125	125	RD 160x1/4	2,63	005450	-	005449
150	150	RD 190x1/4	3,4	005466	-	005470

All data refers to a medium and ambient temperature of +20 °C. Subject to technical changes and colour deviations.

Combiflex Dairy Fitting Cone Sockets

with locknut acc.to
DIN 11851 - cast-on/
pre-fixed, food-grade
quality acc. to EU
10/2011

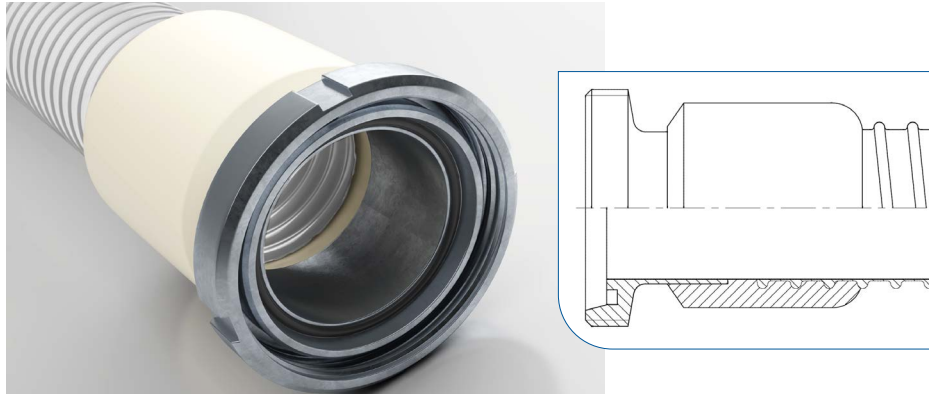

Material

- colour: white
- collar: food-grade polyurethane acc. to EU directive 10/2011 and BfR XXXIX
- locknut: stainless steel
- conical hose sockets, stainless steel

Applications

- Cast-on pipe screw connection acc. to DIN 11851 for Master-PUR Food hoses
- Fitting for solid, liquid and gaseous media in food, pharmaceuticals and chemicals industries
- Temperature Range
- -40°C to +90°C
- peaks to +125°C

Properties

- watertight
- rust-free
- PU-sprue: approved for direct contact with foodstuffs acc.to EU directives 10/2011, 1935/2004 (German Consumer Goods Board) and their latest amendments 1282/2011, 1183/2012, 202/2014 and 2015/174 suitable for dry, watery, acidic, fatty as well as alcoholic food-stuffs (excluding spirits)
- good flow characteristics
- threaded supports: materials acc.to food industry regulations DIN 11851
- odourless/tasteless
- good chemical resistance
- high tensile strength
- dissipation of electrostatic charges via grounding connection between hose and valve/fitting

Production on request

- Order-specific production in listed sizes for Master PUR Food hoses from DN 32 - DN 150

Available on request

- Available on request in aseptic version acc. to DIN 11864-1, as weld-on version, pressed, other materials

DN	Access DS	Thread (DG) acc.to DIN 405-1	weight/piece incl. gate kg	Article no. gate	Article no. cone socket	Article no. threaded socket
32	32	RD 58x1/6"	0,64	005376	005377	005378
38	40	RD 65x1/6"	0,76	005380	005381	-
40	40	RD 65x1/6"	0,81	005384	005498	-
50	50	RD 78x1/6"	1,01	005389	005392	005391
65	65	RD 95x1/6"	1,49	005405	005404	005520
75	80	RD 110x1/4"	1,73	005421	005420	-
80	80	RD 110x1/4"	1,85	005427	005426	005528
100	100	RD 130x1/4"	2,9	005435	005434	005446
125	125	RD 160x1/4"	3,15	005450	005449	-
150	150	RD 190x1/4"	3,4	005466	005470	-

All data refers to a medium and ambient temperature of +20 °C. * Subject to technical changes and colour deviations.

Combiflex Dairy Fitting Ring Seal

for threaded sockets acc.to DIN 11851



Material

- NBR, colour: white

Applications

- NBR, colour: white
- Chemical industry
- Pharmaceutical industry
- Food industry
- for application for connectors to machines and piping
- Sealing rings for screw connectors acc. to DIN 11851
- Sealing rings for solid, liquid and gaseous media in food, pharmaceutical and chemicals industries

Temperature Range

- -25°C to +120°C
- peaks to +150°C

Properties

- materials adhere to the food-grade regulations DIN 11851
- odourless/tasteless
- can be steam-sterilized
- good chemical resistance
- high tensile strength

- Deliverable from stock for sockets with Dairy Fitting outer threads acc. to DIN 11851 from DS 32 - DS 150

DS	inner diameter Di mm	thickness S mm	Article no.
32	36	5	002461
40	42	5	002464
50	54	5	002467
65	71	5	002471
80	85	5	002475
100	104	6	002479
125	130	7	002482
150	155	7	002484

All data refers to a medium and ambient temperature of +20 °C. Subject to technical changes and colour deviations.

Picture credits and titles: © aykulerd - Fotolia.com; Page 3: center: © Deyan Georgiev - Fotolia.com, Page 13: top right: © Kevin - Fotolia.com, center right © popov48 - Fotolia.com, row below from left to right: © umberto leporini - Fotolia.com, © Alterfaller - Fotolia.com, © Illesro - Fotolia.com, © Alterfaller - Fotolia.com, © Alterfaller - Fotolia.com

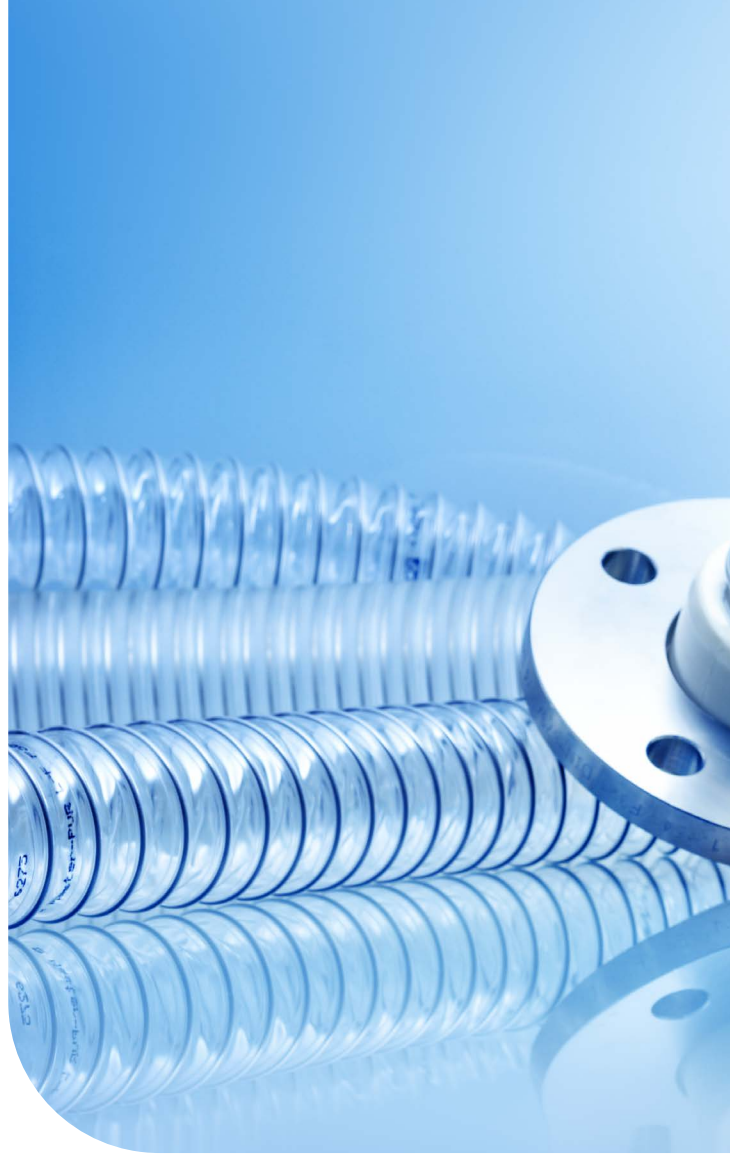

Masterflex SE
Willy-Brandt-Allee 300
45891 Gelsenkirchen, Germany
Tel. +49 209 97077-0
Fax +49 209 97077-33
info.masterflex@masterflexgroup.com
www.masterflexgroup.com
A MASTERFLEX GROUP COMPANY

 **MASTERFLEX GROUP**
Connecting Values